

PROPRIETARY & CONFIDENTIAL INFORMATION

Phoenix Cars, LLC



OVERVIEW

- ▶ Founded in 2003, Phoenix MC, Inc. is a privately held Delaware corporation headquartered in Ontario, California.
- ▶ Phoenix is an Electric Vehicle Manufacturer with a primary focus on the Fleet Market for Class 3 & 4 vehicles; Shuttle Bus, Flatbed Truck and Work Truck.
- ▶ We have made significant progress deploying vehicles into the fleet and municipality sector
- ▶ Not only is our product socially responsible and environmentally sound, it is also a substantial fiscal advantage over traditionally fueled vehicles.

Mission: At Phoenix we build quality Electric Vehicles that exceed customer expectation and make our planet a better place for everyone

PHOENIX – ORGANIZATIONAL CHART

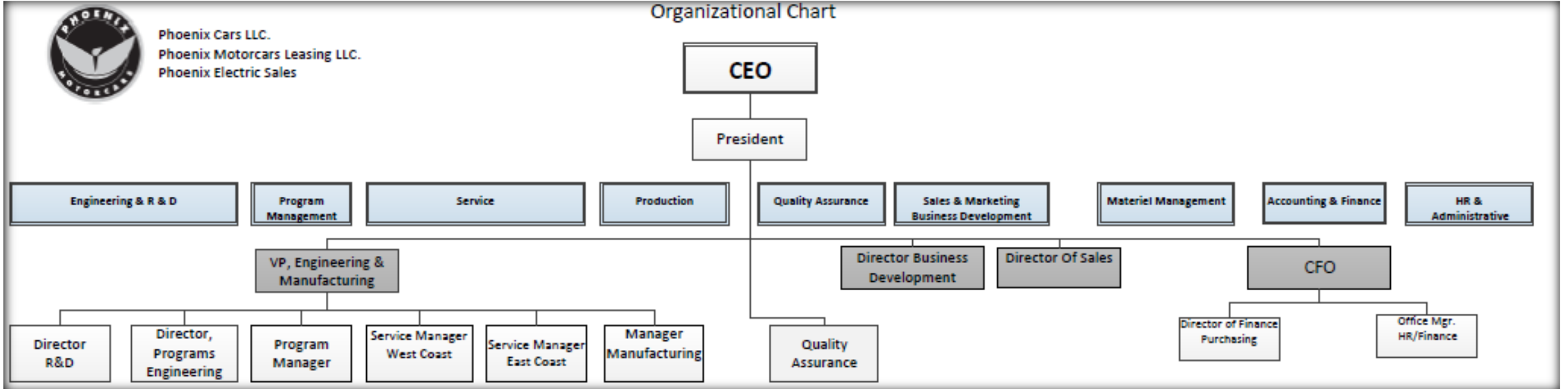

MANUFACTURING



- Phoenix Motorcars maintains a scalable second-stage production line in the US for our initial production activities, including the development and manufacturing of the Phoenix Drive System and its components.



Headquarters & Factory
401 S. Doubleday Av.
Ontario, CA 91761

R&D Facility
13737 Amarillo Av.
Chino, CA 91710

- We are also launching manufacturing operations in Dubai, UAE through our parent company, Al Yousuf, LLC.



OUR PRODUCT

The Patented Phoenix Drive System

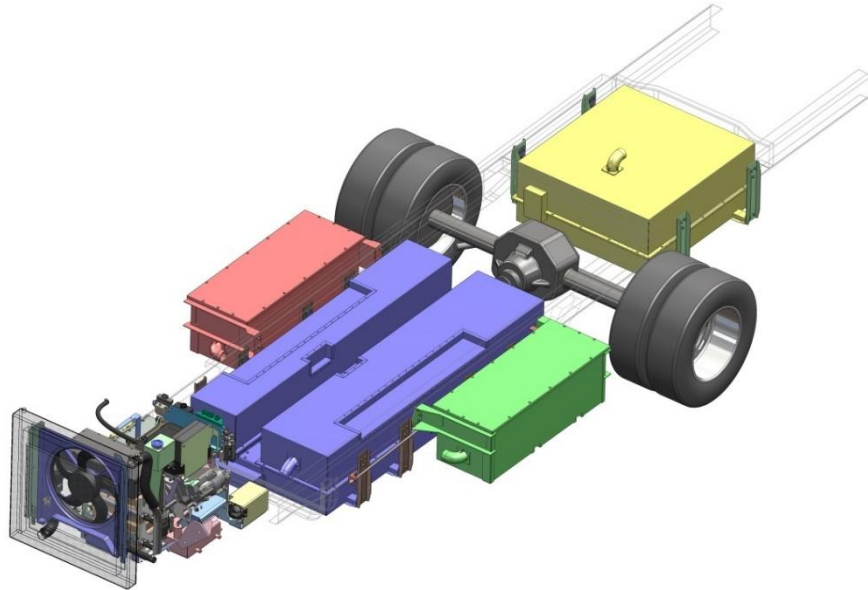

- ❖ Clean, reliable and energy efficient platform
- ❖ Up to 100 mile per charge
- ❖ Level II/Level III charge capable
- ❖ Non-Invasive
- ❖ 5 Year Warranty on Drive Train and Battery System
- ❖ Phoenix Proprietary Telematics System - Connect

PHOENIX TELEMATICS - CONNECT

❖ Range anxiety elimination

- ✓ Real time energy usage reporting
- ✓ Data driven remaining range calculation
- ✓ Automatic email alerts

❖ Charging station use optimization

- ✓ Real time charging monitoring
- ✓ Automatic email alerts

❖ Drivers management / training

- ✓ Data reporting
- ✓ GPS location
- ✓ Driving efficiency Monitoring



PHOENIX TELEMATICS - CONNECT

❖ Vehicle monitoring

- ✓ Battery data
- ✓ Vehicle data

❖ Vehicle maintenance

- ✓ Remote software update
- ✓ Preventive maintenance monitoring
- ✓ Remote diagnostic

❖ State incentive programs reporting

- ✓ Automatic HVIP monthly reports

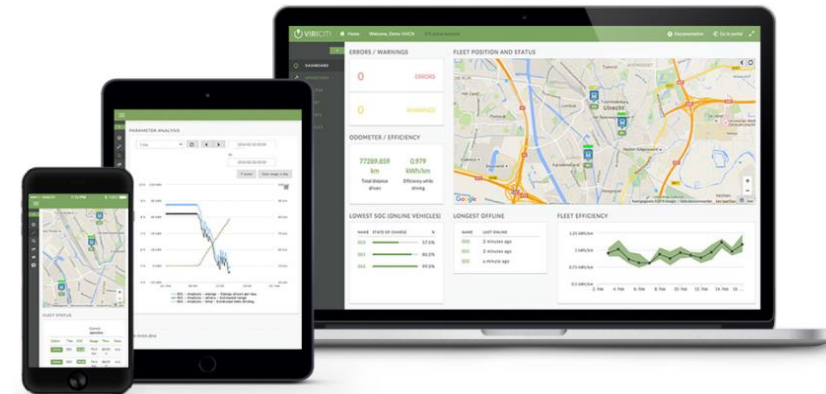

PHOENIX PRODUCTS

Shuttle Bus



Flatbed Truck



Utility Truck



SHUTTLE BUS SPECS

Chassis:	Ford E350/E450
Drive Train:	• RWD
Battery Pack:	• 105 kWh
Driving Range (UDDS):	• Up to 100 Miles
Regenerative Breaking:	• Dual-Mode regenerative braking system
Top Speed:	• 65 mph (Speed Governed)
Certification:	• California Air Resource Board (CARB)
Warranty:	• Battery Warranty: 5 years • Phoenix Drive System Warranty: 5 years
Charge Time:	• J1772 Lvl II (8-9 hours) • CHAdeMO DC Lvl III Rapid Charge (2.5 -3 hours)
Approach Angle/ Departure Angle:	• 27 deg./ 15 deg.
Dimensions (Feet):	• 23.2 L X 9.0 W X 9.5 H
GVWR:	• Up to 14,500 lbs.
Passenger Seating:	• 8-18 Passengers forward or perimeter (ADA option available)
Telematics	• Phoenix Connect



CUSTOMIZABLE CONFIGURATIONS

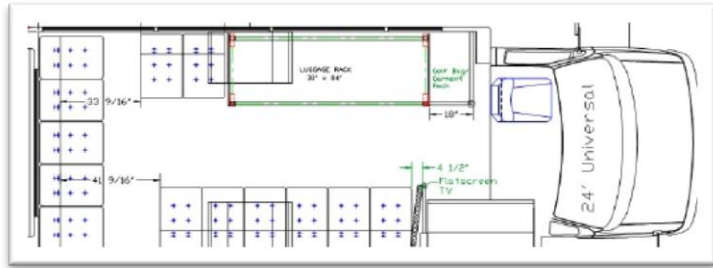

- 13 Passengers, Perimeter, 80" Luggage Rack

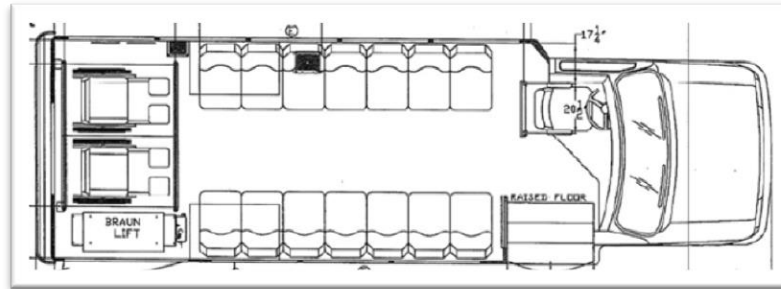

- 14 Passengers, Perimeter Rear Lift, 2 Wheelchair Positions

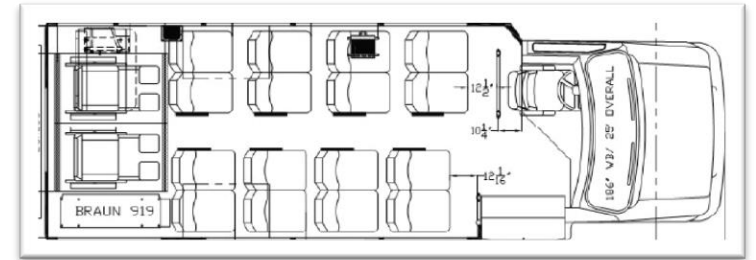

- 16 Passengers, Fwd Facing Rear Lift, 2 Wheelchair Positions

FLATBED/ UTILITY SERVICE TRUCK SPECS

Vehicle Type	Zero Emission Utility Service Truck
Chassis:	Ford E-350/E-450
Drive Train:	<ul style="list-style-type: none"> • RWD
Battery Pack:	<ul style="list-style-type: none"> • 105 kWh
Driving Range (UDDS):	<ul style="list-style-type: none"> • Up to 100 Miles
Regenerative Breaking:	<ul style="list-style-type: none"> • Dual-Mode regenerative braking system
Top Speed:	<ul style="list-style-type: none"> • 65 mph (Speed Governed)
Certification:	<ul style="list-style-type: none"> • California Air Resource Board (CARB)
Chassis:	<ul style="list-style-type: none"> • Battery Warranty: 5 years • Phoenix Drive System Warranty: 5 years
Charge Time:	<ul style="list-style-type: none"> • J1772 Lvl II (8-9 hours) • DC Lvl III Rapid Charge (2.5 -3 hours)
Dimensions:	<ul style="list-style-type: none"> • 23 x 9 x 9.5 feet (L x W x H)
GVWR:	<ul style="list-style-type: none"> • Up to 14,500 lbs.
Telematics	<ul style="list-style-type: none"> • Phoenix Connect



YEAR OVER YEAR GROWTH



November 2014
Air Force: V2G Bus
deployed at LAAFB



March 2015
Navy: Flatbed
V2G deployed
to US Navy



May 2015
SP+: 1st EV
deployed at
LAX



June 2015
JPL: Buses
deployed at
NASA campus



April 2016
Irvine: 1st
work truck
delivered to
City of Irvine



O2-Q4 2016
L&R: 1st all EV
fleet deployed
at LAX, SD and
Atlanta Airport

CUSTOMER BASE

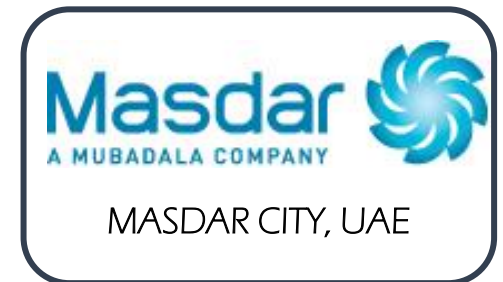

CUSTOMER BASE



CUSTOMER BASE



CUSTOMER BASE



CUSTOMER BASE



WallyPark

Premier Airport Parking.™

WALLYPARK

Atlanta | Los Angeles |
San Diego



JOE'S AUTO PARKS

Atlanta | Los Angeles

CUSTOMER BASE



CUSTOMER BASE



CUSTOMER BASE





Phoenix Cars, LLC
401 South Doubleday Ave.
Ontario, California 91761
USA
Ph. +1 909 987 0815
For Sales: +1-844-400-7463
Email:
Info@phoenixmotorcars.com